

Varenummer: 204250M16150A0U

Beskrivelse: E+G Justerfod
GN 42-50-M16-150-A0-U

Note: U Uden møtrik, sekskant i toppen, spændeflade i bunden

Mål

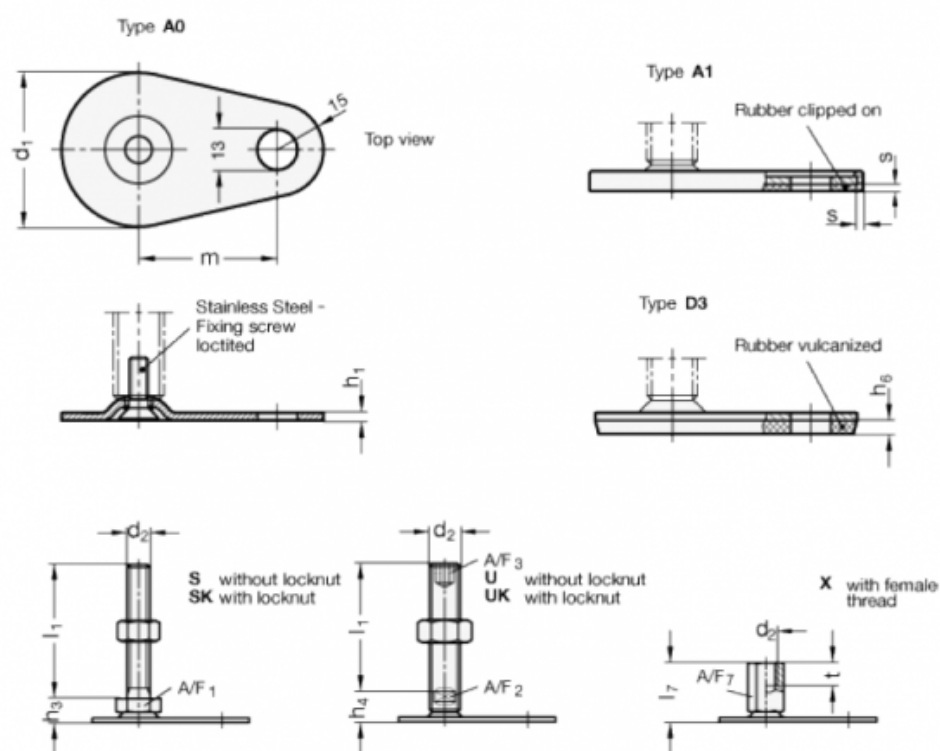

A/F2 = 12	m = 45
A/F3 = 8	s =
d1 = 50	
d2 = M16	
h1 = 2.5	
h4 = 17	
h6 =	
l1 = 150	